

Identification Information - Dana Outdrives

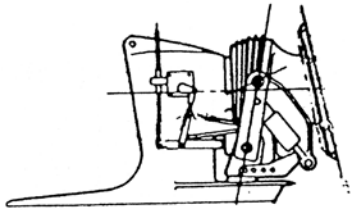

TYPE A WITHOUT SPACER
OPEN BOOT

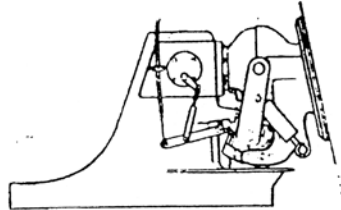

TYPE B WITH BUILT-IN EXT.
SHIELDED BOOT

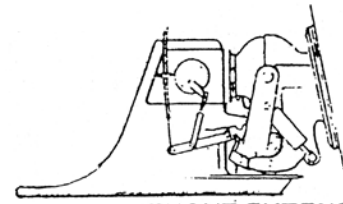

TYPE C WITHOUT EXTENSION
SHIELDED BOOT

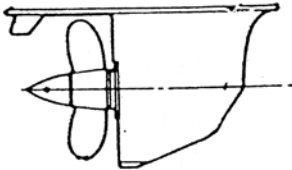

MODEL 80/81

17" Prop

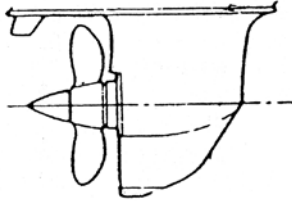

MODEL 82/83

19" Prop

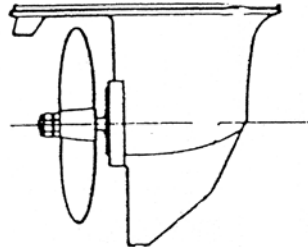

MODEL 91

20" Prop

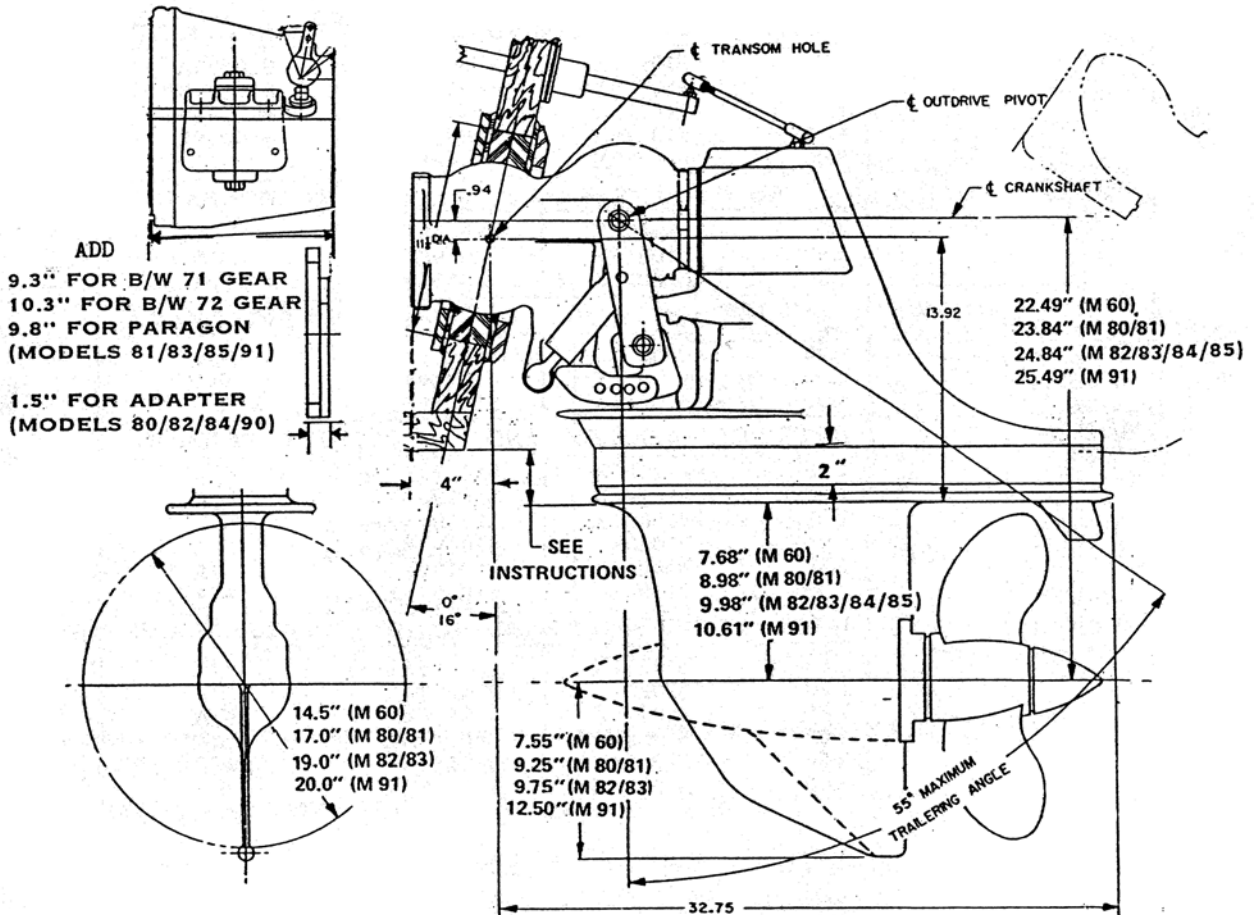

TYPE B UPPER HOUSING WITH BUILT-IN TWO INCH EXTENSION - SHIELDED BOOT FORM